



7.9 - SISTEMA DECORATIVO PARA PUERTAS

PERFILERÍA

DIVINA DOORS

NOVEDAD

SISTEMA DIVINA

La puerta batiente Divina es un sistema simple y minimalista. El exclusivo sistema de montaje de perfiles y accesorios permiten la construcción de puertas a medida, siempre diferentes entre sí, utilizando las herramientas de trabajo más comunes. Los mejores materiales junto con las más modernas técnicas de tratamiento superficial hacen de Divina batiente un producto sólido y resistente.

HERMOSO Y ELEGANTE: ¡SOLO MIRALO!

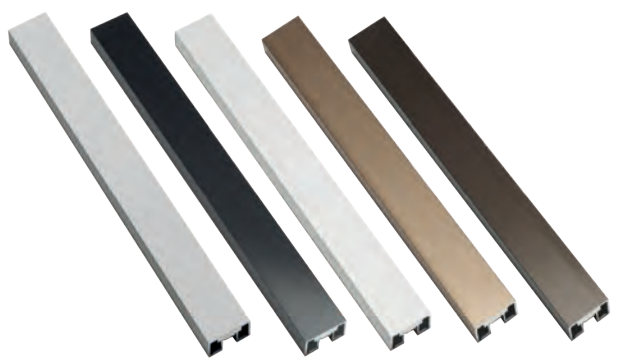

Anodizado plata Anodizado negro Lacado blanco Anodizado bronce claro Anodizado bronce oscuro

SISTEMA DECORATIVO PARA PUERTAS | SISTEMA DIVINA

Características técnicas:

- Para puertas de vidrio templado de 8 mm
- Para paneles fijos de 8/10 mm
- Compatible con cerraduras y tirador magnético de la serie divina
- Posibilidad de combinar varios acabados



Ver vídeo demostrativo www.vitrum.es



NOVEDAD

PERFIL PRE-MARCO MULTI APLICACIÓN

VP015

Acabados:

Anodizado negro	1500 mm	5205.15 NE
	3000 mm	5205.30 NE

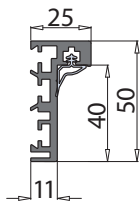

GOMA PERIMETRAL

Acabados:

Negro	5205.1 NE
Blanco	5205.1 BL

*Precio por metro



PERFIL COMPENSACIÓN A MURO

P-033

Perfil opcional para regulación de perfil 5205.30

Acabados:

Anodizado negro	3000 mm	5206.30 NE
-----------------	---------	-------------------

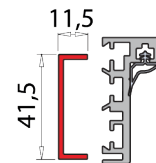

PERFIL VERTICAL

DIV-102

Acabados:

Anodizado negro	3000 mm	5200.30 NE
-----------------	---------	-------------------

PERFIL VERTICAL FRESADO

Acabados:

Anodizado negro	3000 mm	5200.30F NE
-----------------	---------	--------------------



PERFIL HORIZONTAL

DIV-103

Acabados:

Anodizado negro	3000 mm	5201.30 NE
-----------------	---------	-------------------

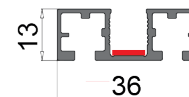

PERFIL VERTICAL PARA ACOPLAR CON 5203.30

DIV-105

Acabados:

Anodizado negro	3000 mm	5202.30 NE
-----------------	---------	-------------------

PERFIL VERTICAL FRESADO PARA ACOPLAR CON 5203.30

Acabados:

Anodizado negro	3000 mm	Izquierda	5202.30IF NE
		Derecha	5202.30DF NE

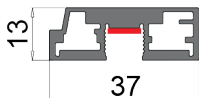

PERFIL VERTICAL PARA ACOPLAR CON 5202.30

DIV-104

Acabados:

Anodizado negro	3000 mm	5203.30 NE
-----------------	---------	-------------------

PERFIL VERTICAL FRESADO PARA ACOPLAR CON 5202.30

Acabados:

Anodizado negro	3000 mm	Izquierda	5203.30IF NE
		Derecha	5203.30DF NE

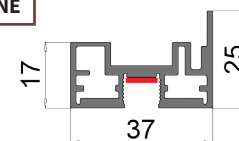

PERFIL DIVISIÓN INTERNA

DIV-204

Acabados:

Anodizado negro	3000 mm	5204.30 NE
-----------------	---------	-------------------

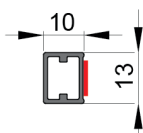
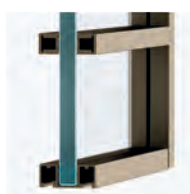

PERFIL H DIVISORIO VIDRIO FIJO

DIV-208

Acabados:

Anodizado negro	3000 mm	5209.30 NE
-----------------	---------	-------------------

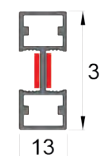



JUNQUILLO "A" PARA PRE MARCO

P-088A
B-146

Acabados:

Anodizado negro	3000 mm	5207.30 NE
-----------------	---------	-------------------

GOMA PARA JUNQUILLO "A"

Acabados:

3000 mm	5207.1
---------	---------------

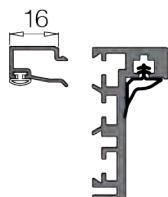

JUNQUILLO "B" PARA PRE MARCO

P-088B
VP016
VP017

Acabados:

Anodizado negro	3000 mm	5208.30 NE
-----------------	---------	-------------------

GOMA PARA JUNQUILLO "B"

Acabados:

V 8 mm	5208.2
V 10 mm	5208.1

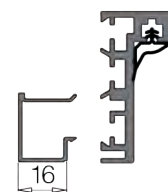

PERFIL CILP PARA VIDRIO FIJO

P-058

Acabados:

Anodizado negro	1500 mm	5218.15 NE
	3000 mm	5218.30 NE

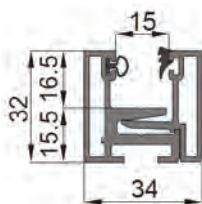

GOMA GLOBO PARTE FIJA

VP-210
VP-210--12

Acabados:

V 8 mm	5216.2
V 10 mm	5216.1

GOMA PARTE MÓVIL

VP-018
VP-019

Acabados:

V 8 mm	5217.2
V 10 mm	5217.1

SET ESCUADRAS PARA PRE-MARCO 5205.15/30

P-012-CF4

Acabados:

5214



KIT ENSAMBLADO PLANTILLA ESCUADRAS

DIV-100-KIT

Acabados:

5213



PASADOR PUERTA SEMI-FIJA

DIV-003

Acabados:

Anodizado negro	5215 NE
-----------------	----------------

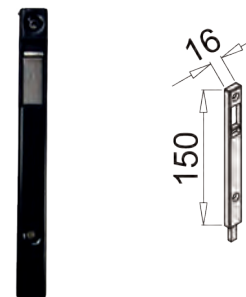

JUEGO DE BISAGRAS PARA PERFIL DIVINA

DIV-V742

Vidrio 8 mm

Acabados:

5220.K1 NE



CERRADURA CENTRAL MAGNÉTICA SIN LLAVE

MV-740

Manetas no incluidas

Acabados:

Anodizado negro **5210 NE**

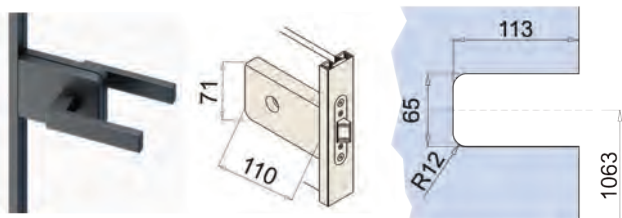

CERRADURA VERTICAL MAGNÉTICA CON LLAVE

MV-741

Manetas y bombín no incluidos

Acabados:

Anodizado negro **5219 NE**

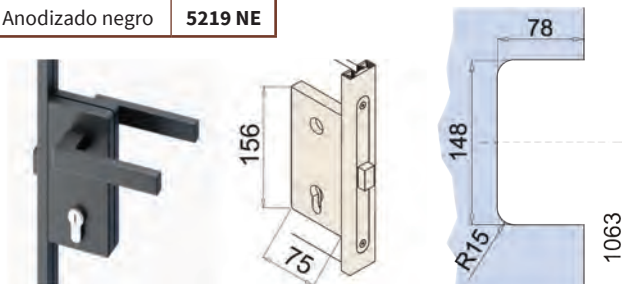

KIT MANETAS PARA CERRADURAS DIVINA

V-921-ELGA

Manetas para 5210 y 5219

Acabados:

Anodizado negro **5211 NE**

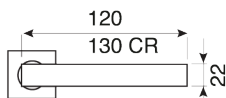

BOMBÍN PARA CERRADURA

C-06

Para cerradura 5219

Acabados:

5219.1

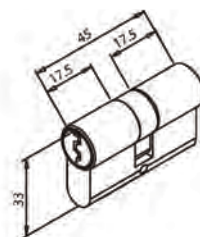

CERRADERO MAGNÉTICO PARA CERRADURAS DIVINA

Compatible con 5210 y 5219

Acabados:

5210.1C NE

CP-015 M

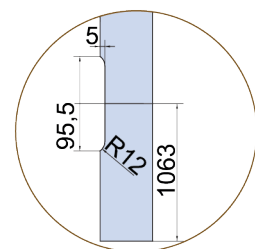
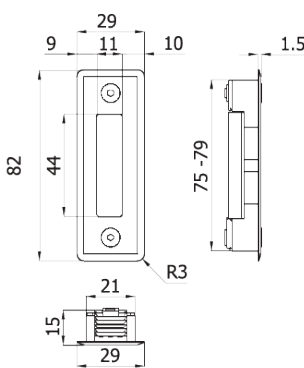

TIRADOR DOBLE MAGNÉTICO

Acabados:

Anodizado negro **5212 NE**

DIV-M101

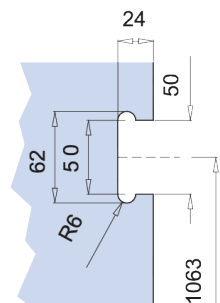
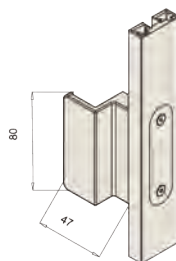



DIVINA BATIENTE

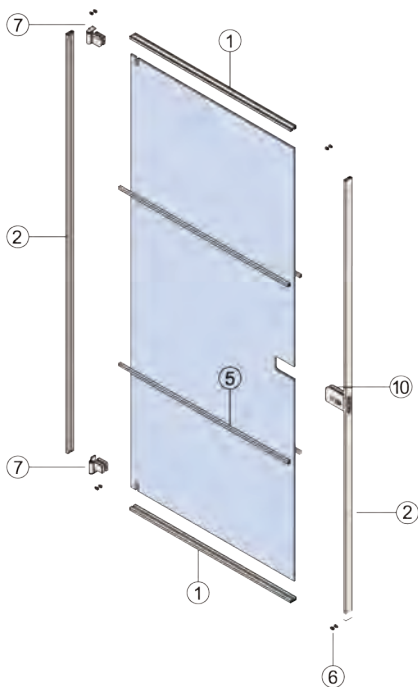

DIVINA BATIENTE SEMIFIJO

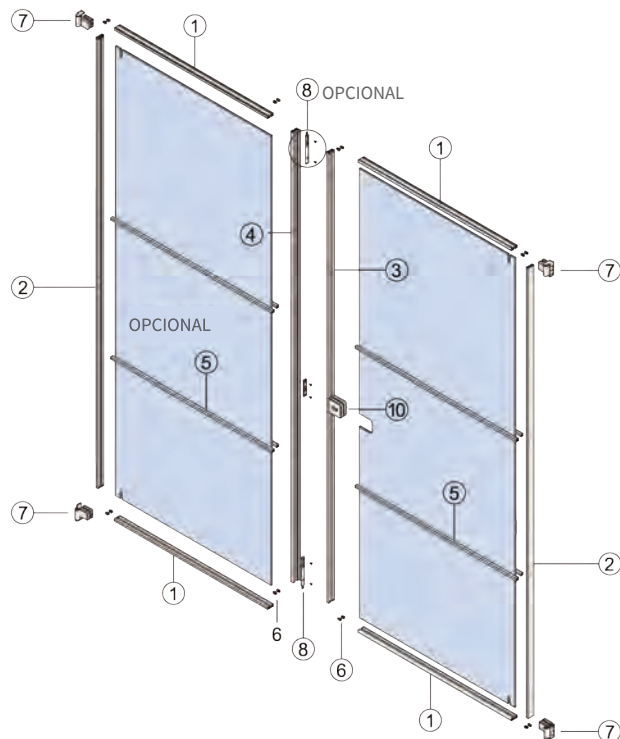

①
PERFIL HORIZONTAL



5201.30

②
PERFIL VERTICAL

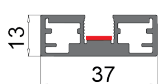

5200.30

③
PERFIL VERTICAL
Para acoplar 5203.30

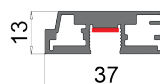

5202.30 5202.30F

④
PERFIL VERTICAL
Para acoplar 5202.30

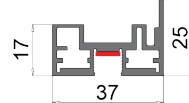

5203.30 5203.30F

⑤
PERFIL DIVISIÓN INTERNA
(opcional)

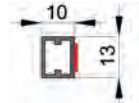

5204.30

⑥
KIT ENSAMBLADO
PARA 1 PUERTA



5213

⑦
JUEGO BISAGRAS
PARA 1 PUERTA



5220.K1

⑧
PASADOR PUERTA
SEMI-FIJA

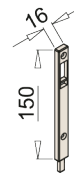

5215

⑨
RECIBIDOR MAGNÉTICO
PARA CERRADURAS

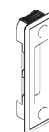

5210.1C

⑩
CERRADURA CENTRAL
MAGNÉTICA

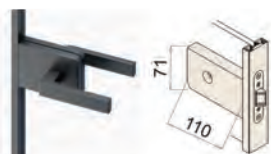

5210

⑪
CERRADURA VERTICAL
MAGNÉTICA CON LLAVE

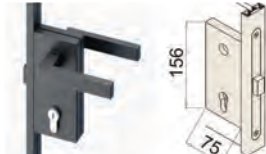

5219

⑫
TIRADOR DOBLE
MAGNÉTICO

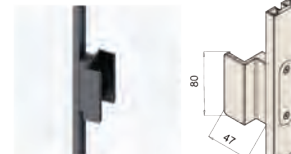

5212

PUERTA INDIVIDUAL
CORTE PERFILERÍA Y VIDRIOS

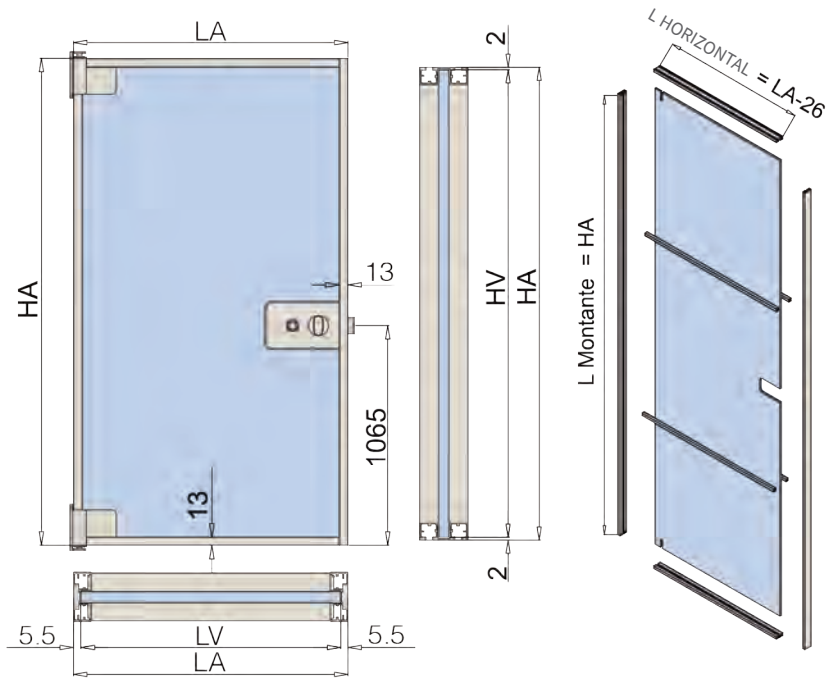

LV = LA - 11
HV = HA - 4

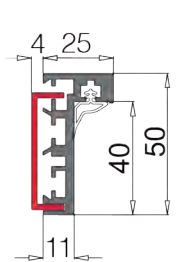
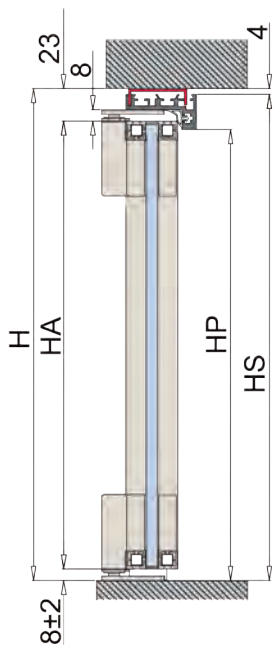

PERFIL OPCIONAL 5206.30

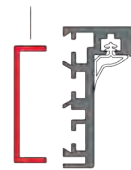

CON PERFIL 5206.30

LA = LP - 42
HA = H - 31
LS = LP - 8
HS = H - 4

SIN PERFIL 5206.30

LA = LP - 34
HA = H - 27
LS = LP
HS = H

VIDRIO

LV = LA - 11
HV = HA - 4

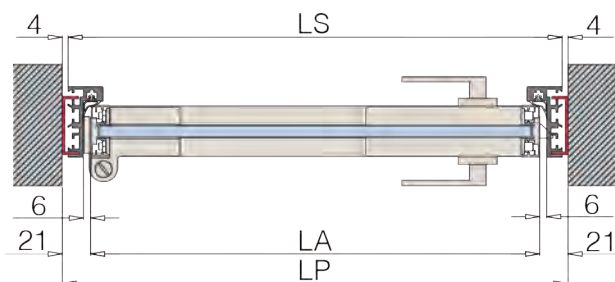



PUERTA + SEMI-FIJO CORTE PERFILERÍA Y VIDRIOS

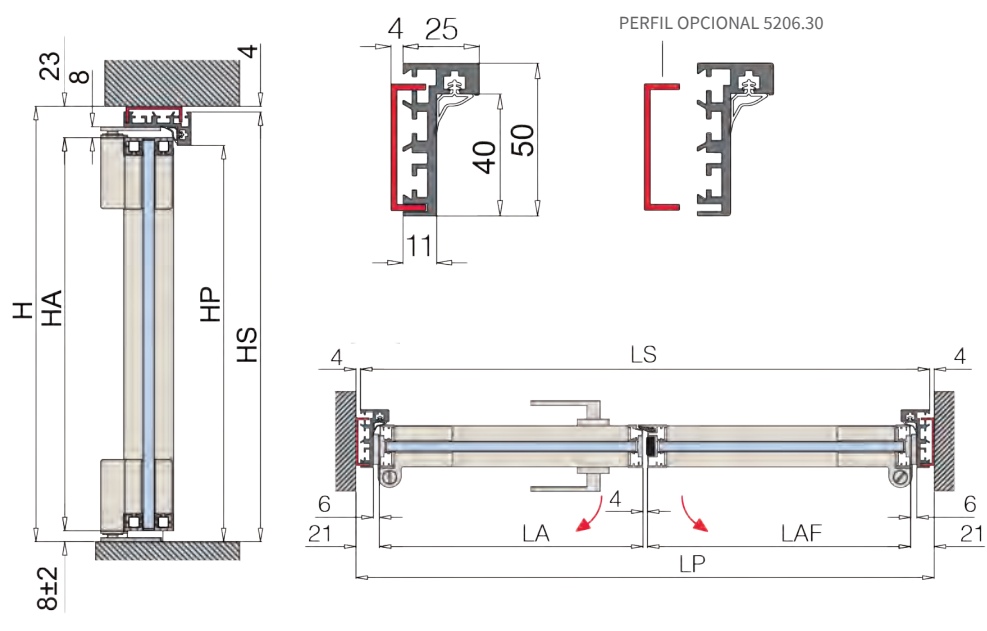
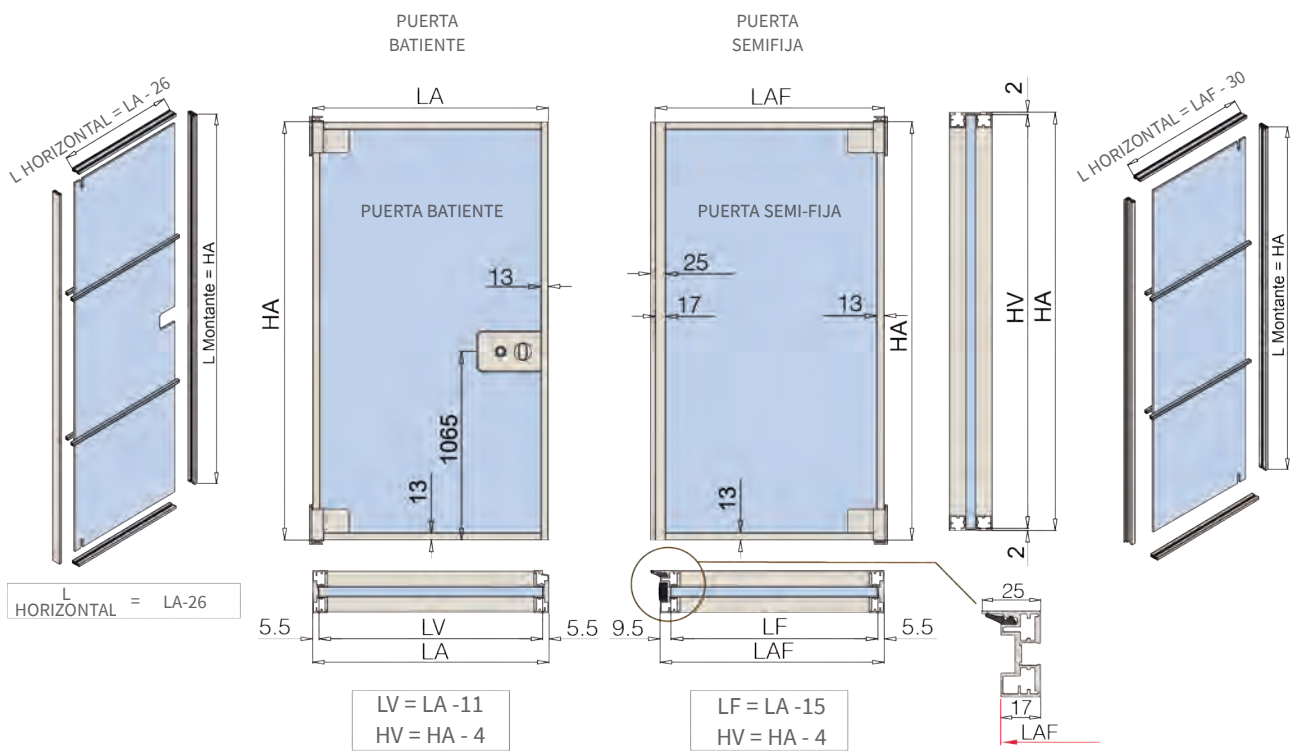
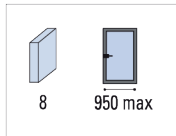

CON PERFIL 5206.30

$$LA = LAF = (LP - 46) / 2$$

$$HA = H - 31$$

$$LS = LP - 8$$

$$HS = H - 4$$

SIN PERFIL 5206.30

$$LA = LAF = (LP - 38) / 2$$

$$HA = H - 27$$

$$LS = LP$$

$$HS = H$$

VIDRIO PUERTA BATIENTE

$$LV = LA - 11$$

$$HV = HA - 4$$

VIDRIO SEMI FIJO

$$LF = LAF - 15$$

$$HV = HA - 4$$

PUERTA CON FIJOS LATERALES
CORTE PERFILERÍA Y VIDRIOS

